



Features

- Three-Phase 340 ~ 550VAC wide range input (Dual phase operation possible)
- 63mm slim width
- Built-in passive PFC function compliance to EN61000-3-2
- High efficiency 92% and low power dissipation
- Protections: Short circuit / Overload / Over voltage / Over temperature
- Cooling by free air convection
- Full power between -30~+60°C
- Built-in constant current limiting circuit
- Can be installed on DIN rail TS-35/7.5 or 15
- UL61010(industrial control equipment)approved
- EN61000-6-2(EN50082-2) industrial immunity level
- DC OK relay contact
- 3 years warranty

Applications

- Industrial control system
- Semiconductor fabrication equipment
- Factory automation
- Electro-mechanical apparatus

Description

TDR-240 is one economical slim 240W Din rail power supply series, adapt to be installed on TS-35/7.5 or TS-35/15 mounting rails. The body is designed 63mm in width, which allows space saving inside the cabinets. The entire series adopts the full range AC input from 3ϕ 340VAC to 550VAC (Dual Phase operation possible) and conforms to EN61000-3-2, the norm the European Union regulates for harmonic current. TDR-240 is designed with metal housing that enhances the unit's power dissipation. With working efficiency up to 92 %, the entire series can operate at the ambient temperature between -30°C and 70°C under air convection. It is equipped with constant current mode for over-load protection, fitting various inductive or capacitive applications. The complete protection functions and relevant certificates for industrial control apparatus (UL61010, EN61558-2-16 approved, and etc.) make TDR-240 a very competitive power supply solution for industrial applications.

Model Encoding

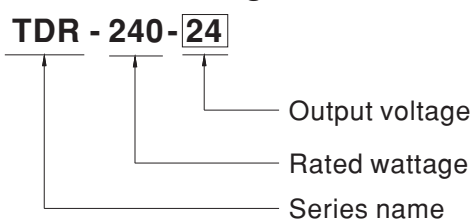



SPECIFICATION

MODEL		TDR-240-24	TDR-240-48	
OUTPUT	DC VOLTAGE	24V	48V	
	RATED CURRENT	10A	5A	
	CURRENT RANGE	0 ~ 10A	0 ~ 5A	
	RATED POWER	240W	240W	
	RIPPLE & NOISE (max.) <small>Note.2</small>	100mVp-p	120mVp-p	
	VOLTAGE ADJ. RANGE	24 ~ 28V	48 ~ 55V	
	VOLTAGE TOLERANCE <small>Note.3</small>	± 1.0%	± 1.0%	
	LINE REGULATION	± 0.5%	± 0.5%	
	LOAD REGULATION	± 1.0%	± 1.0%	
	SETUP, RISE TIME	2000ms, 60ms/400VAC 1500ms, 60ms/500VAC at full load		
HOLD UP TIME (Typ.)	20ms / 400VAC 40ms / 500VAC at full load			
INPUT	VOLTAGE RANGE <small>Note.4</small>	Three-Phase 340 ~ 550VAC (Dual phase operation possible in connecting L1,L3,FG or L2,L3,FG) or 480 ~ 780VDC		
	FREQUENCY RANGE	47 ~ 63Hz		
	POWER FACTOR (Typ.)	PF ≥ 0.53/400VAC PF ≥ 0.52/500VAC at full load		
	EFFICIENCY (Typ.)	92%	92%	
	AC CURRENT (Typ.)	0.69A/400VAC 0.6A/500VAC		
	INRUSH CURRENT (Typ.)	COLD START 50A		
	LEAKAGE CURRENT	<2mA / 530VAC		
PROTECTION	OVERLOAD	105 ~ 130% rated output power Protection type : Constant current limiting, unit will hiccup after 3 sec.		
	OVER VOLTAGE	30 ~ 36V	56 ~ 65V	
	OVER TEMPERATURE	Shut down o/p voltage, recovers automatically after temperature goes down Protection type : Hiccup mode, recovers automatically after fault condition is removed.		
FUNCTION	DC OK REALY CONTACT RATINGS (max.)	60VDC/0.3A, 30VDC/1A, 30VAC/0.5A resistive load		
ENVIRONMENT	WORKING TEMP. <small>Note.5</small>	-30 ~ +70°C (Refer to "Derating Curve")		
	WORKING HUMIDITY	20 ~ 95% RH non-condensing		
	STORAGE TEMP., HUMIDITY	-40 ~ +85°C, 10 ~ 95% RH non-condensing		
	TEMP. COEFFICIENT	± 0.05%/°C (0 ~ 60°C)		
	VIBRATION	Component:10 ~ 500Hz, 2G 10min./1cycle, 60min. each along X, Y, Z axes; Mounting: Compliance to IEC60068-2-6		
	OPERATING ALTITUDE <small>Note.6</small>	5000 meters		
SAFETY & EMC (Note 7)	OVER VOLTAGE CATEGORY	III ; According to EN61558, EN50178, EN60664-1, EN62477-1, EN60204-1; altitude up to 2000 meters		
	SAFETY STANDARDS	UL61010, EN61558-2-16, EAC TP TC 004 approved		
	WITHSTAND VOLTAGE	I/P-O/P:4.87KVAC I/P-FG:2.4KVAC O/P-FG:0.5KVAC O/P-DC OK:0.5KVAC		
	ISOLATION RESISTANCE	I/P-O/P, I/P-FG, O/P-FG:>100M Ohms / 500VDC / 25°C / 70% RH		
	EMC EMISSION	Parameter	Standard	Test Level / Note
		Conducted	EN61204-3	Class B
		Radiated	EN61204-3	Class B
		Harmonic Current	EN61000-3-2	Class A
		Voltage Flicker	EN61000-3-3	-----
	EMC IMMUNITY	EN55024 , EN61204-3		
		Parameter	Standard	Test Level / Note
		ESD	EN61000-4-2	Level 4, 15KV air ; Level 4, 8KV contact
		Radiated Field	EN61000-4-3	Level 3
EFT / Burst		EN61000-4-4	Level 3	
Surge		EN61000-4-5	Level 4, 2KV / Line-Line, Level 4, 4KV/ Line-Earth	
Conducted		EN61000-4-6	Level 3	
Magnetic Field		EN61000-4-8	Level 4	
Voltage Dips and Interruptions	EN61000-4-11	> 95% dip 0.5 periods, 30% dip 25 periods > 95% interruptions 250 periods		
OTHERS	MTBF	515.4K hrs min. Telcordia SR-332(Bellcore); 215.6K hrs min. MIL-HDBK-217F (25°C)		
	DIMENSION	63*125.2*113.5mm (W*H*D)		
	PACKING	1Kg ; 12pcs/13Kg/1.06CUFT		
NOTE	<ol style="list-style-type: none"> All parameters NOT specially mentioned are measured at 400VAC input, rated load and 25°C of ambient temperature. Ripple & noise are measured at 20MHz of bandwidth by using a 12" twisted pair-wire terminated with a 0.1uf & 47uf parallel capacitor. Tolerance : includes set up tolerance, line regulation and load regulation. Dual phase operation is allowed under certain derating to output load. Please refer to derating curves for details. Installation clearances : 40mm on top, 20mm on the bottom, 5mm on the left and right side are recommended when loaded permanently with full power. In case the adjacent device is a heat source, 15mm clearance is recommended. The ambient temperature derating of 3.5°C/1000m is needed for operating altitude higher than 2000m(6500ft). The power supply is considered a component which will be installed into a final equipment. The final equipment must be re-confirmed that it still meets EMC directives. For guidance on how to perform these EMC tests, please refer to "EMI testing of component power supplies." (as available on http://www.meanwell.com) 			

■ BLOCK DIAGRAM

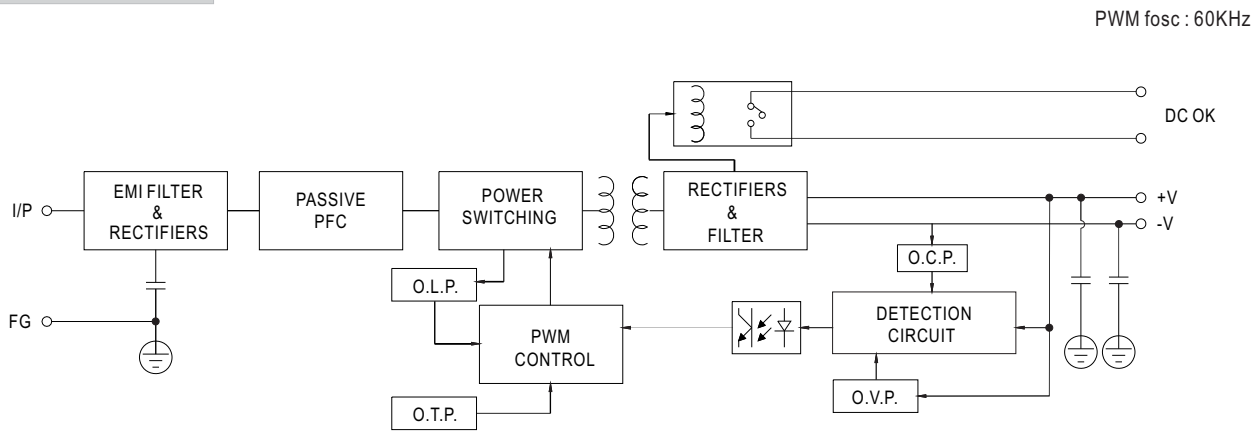

■ DERATING CURVE

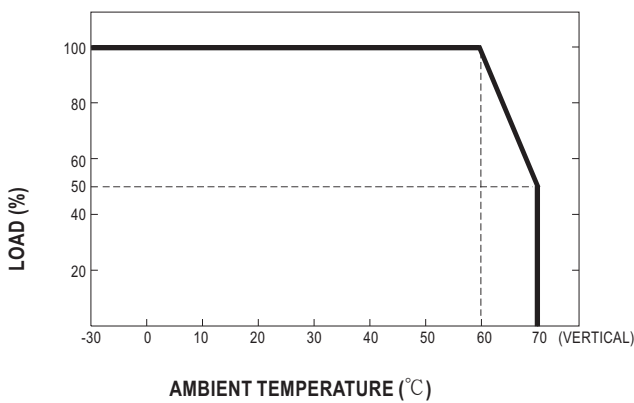

■ OUTPUT DERATING VS INPUT VOLTAGE

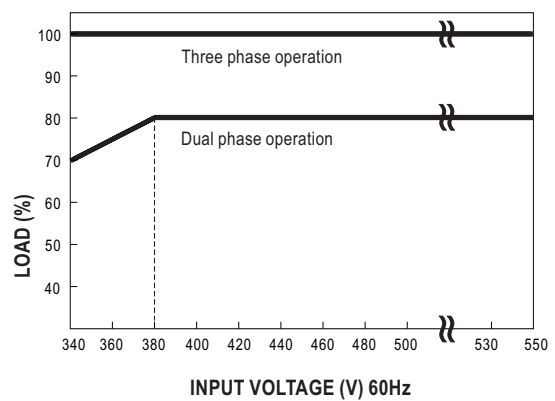

Note : When the dual phase input voltage is between 340~380Vac and ambient temperature is between -10°C~-30°C, the power supply may experience hiccup at cold start. The power supply will start up normally after 5~10 seconds.

■ DC OK RELAY CONTACT

Contact Close	PSU turns on / DC OK.
Contact Open	PSU turns off / DC Fail.
Contact Ratings (max.)	30VDC/1A, 30VAC/0.5A resistive load.

Terminal Pin No. Assignment (TB2)

Pin No.	Assignment
5,6	DC OK Relay Contact

※ Please contact MEAN WELL for more details.

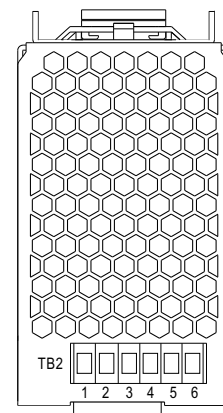

MECHANICAL SPECIFICATION

Case No. 979D Unit:mm

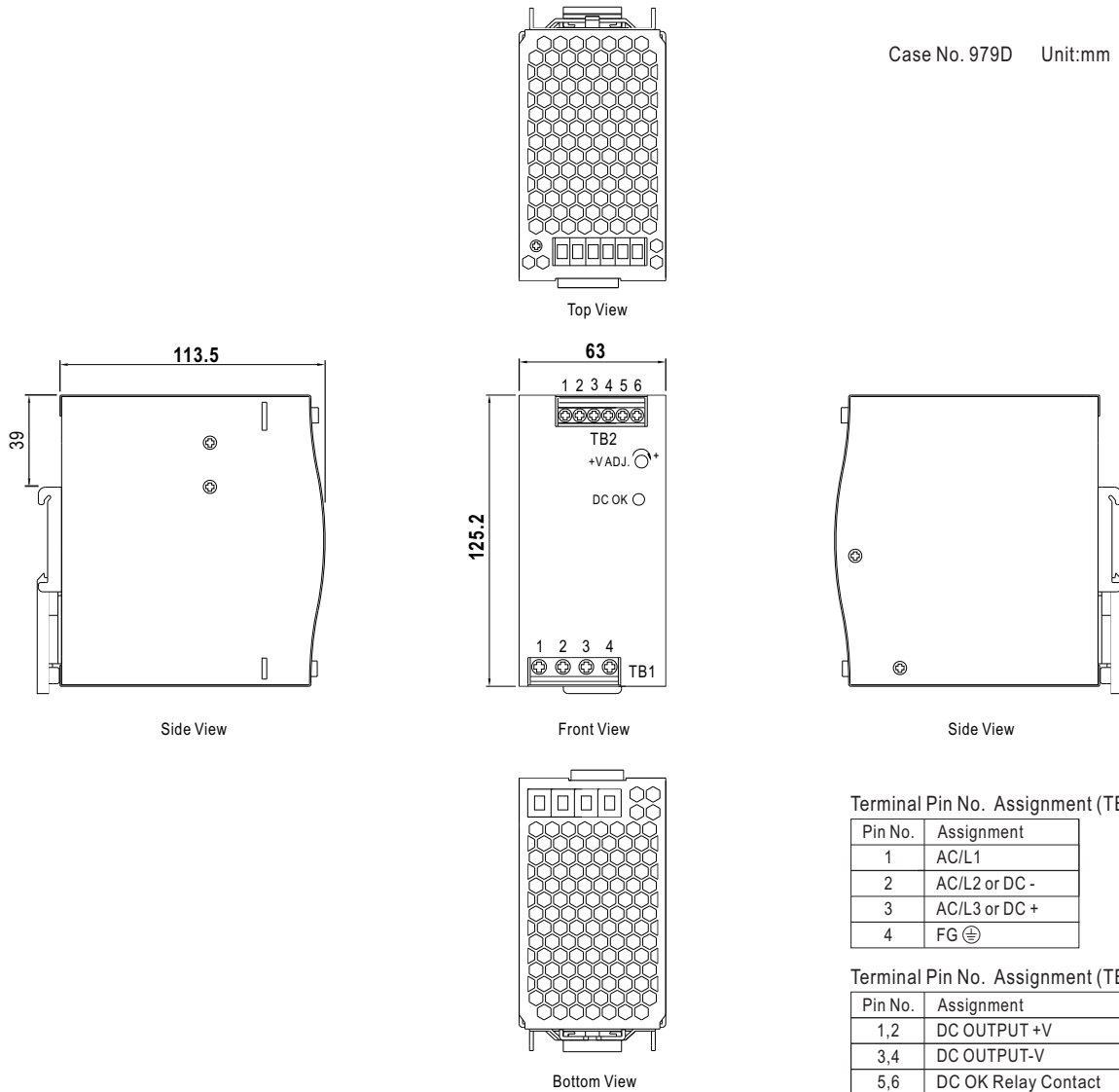

Installation Instruction

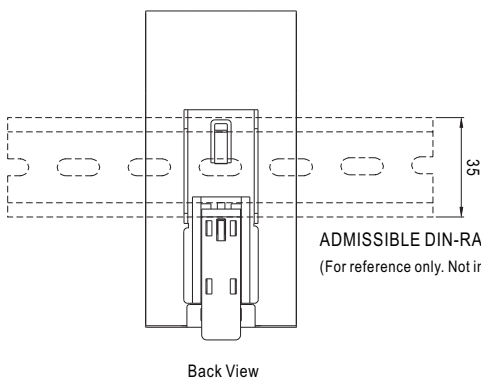

ADMISSIBLE DIN-RAIL: TS35/7.5 OR TS35/15
(For reference only. Not included with unit.)

This series fits DIN-RAIL TS35/7.5 or TS35/15.
For installation details, please refer to the Instruction manual.

Installation Manual

Please refer to : <http://www.meanwell.com/manual.html>